

BETTY 11

Puissance supérieure

Élégant et solide, réchauffe les espaces les plus importants. Rapport puissance-prix étonnant. La possibilité de sortie supérieure des fumées réduit l'encombrement.



Coin arrondi



Ventilation ambiant



A Prédisposition de sortie des fumées supérieures



A Sortie des fumées postérieure
B Entrée d'air de combustion



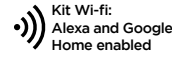







PELLET AIR
BETTY 11



BETTY 11

| | | |
|--|----------------------------|----------------------------|
| Classe énergétique | A+ | |
| Conformité | EN 14785: 10-2006 | |
| Dimensions | L 54 x P 53 x H 104 cm | |
| Volume emballage | 0,53 m ³ | |
| Poids poêle | kg 93 | |
| Puissance thermique introduite | kW 10,9 | |
| Puissance thermique nominale (max) | kW 9,7 | |
| Puissance thermique réduite (min) | kW 4,8 | |
| Rendement à la puissance % | min 93,2 % | max 88,8 % |
| Emissions de CO (au 13% de O ₂) | min 237 mg/Nm ³ | max 82 mg/Nm ³ |
| Émissions CO (13% O ₂) | min 0,019 Vol.-% | max 0,009 Vol.-% |
| Émissions OGC (13% O ₂) | min 3 mg/Nm ³ | max 3 mg/Nm ³ |
| Émissions NOx (13% O ₂) | min 137 mg/Nm ³ | max 142 mg/Nm ³ |
| Contenu moyen poussières (13% O ₂) | 15 mg/Nm ³ | |
| Tirage minimale cheminée | min 10 Pa | max 12 Pa |
| Diamètre sortie fumées | Ø 80 mm | |
| Diamètre conduit d'aspiration | Ø 50 mm | |
| Capacité réservoir | kg 26 | |
| Consommation granulés | min 1,06 kg / h | max 2,25 kg / h |
| Tension d'alimentation | V/HZ 230 / 50 | |
| Absorption électrique nominale | min 15 W | max 60 W |
| Absorption électrique en allumage | 320 W | |
| Volume de chauffe m ³ | 127 / 256 m ³ | |
| Niveau sonore dB | dB 37 / 45 | |
| Combustible | PELLET EN PLUS A1 | |

PLUS

-  Poêle étanche
-  Brasero en fonte
-  Sortie des fumées postérieure ou prédisposition supérieure
-  Système de modulation
-  Silence (à puissance réduite)
-  Programmation journalière/hebdomadaire
-  5 régulations de puissance
-  Écran 7 langues
-  Poignée anti-brûlure
-  Vitre céramique

FINITIONS



Métal
Rouge





Métal
Blanc



Métal
Anthracite

OPTIONAL

-  Wi-Fi
-  Télécommande
-  Tiroir à cendres

BETTY 11.0



PELLET AIR

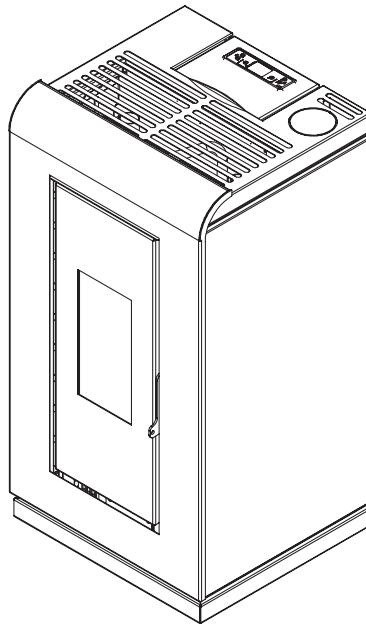
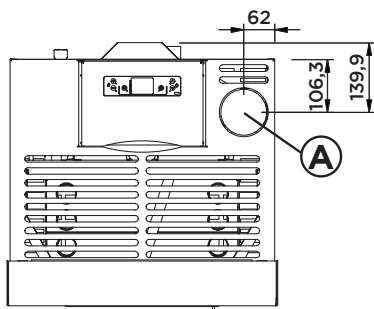
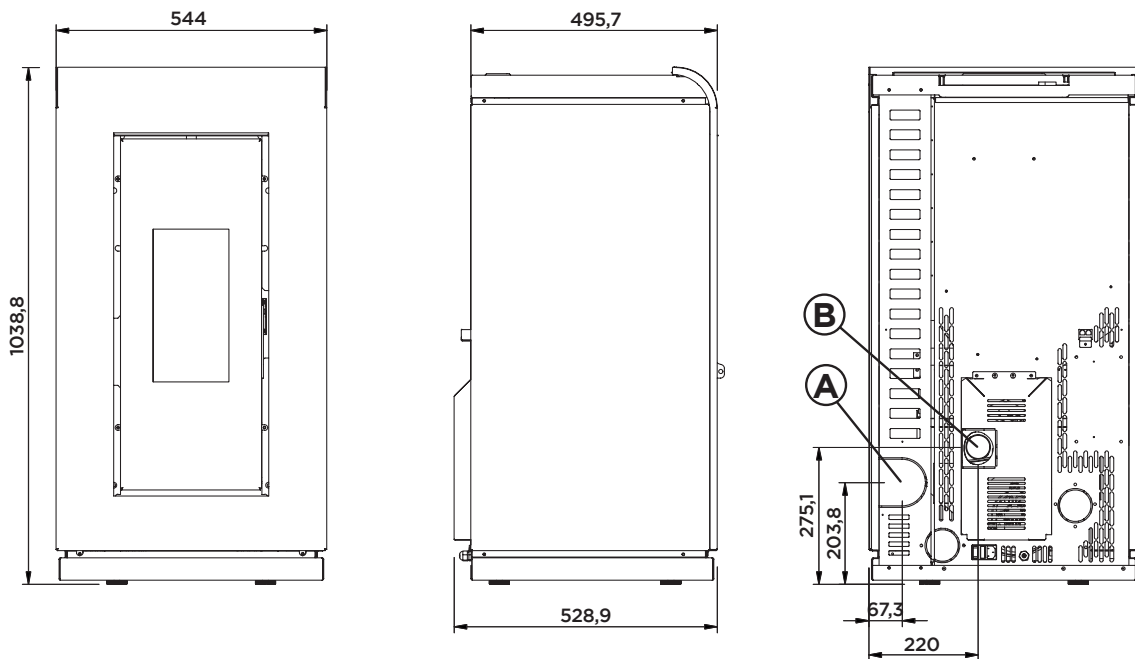

| | |
|--|---|
| Sortie des fumées | A |
| Entrée d'air comburant | B |
| Uscita Canalizzazione | - |
| Canalisable jusqu'à mètres linéaires (consulter le manuel pour une correcte installation) | - |