

SOFIA 9.0 UP



Vitre céramique



Version SOFIA 9.0 UP
Sortie fumées supérieure



Détail finitions chromées











PELLET AIR
SOFIA 9.0 UP



SOFIA 9.0 UP

Classe énergétique	A+
Conformité	EN 14785: 10-2006
Dimensions	L 48 x P 49 x H 93 cm
Volume emballage	0,53 m ³
Poids poêle	kg 62
Puissance thermique introduite	kW 8,9
Puissance thermique nominale (max)	kW 8,2
Puissance thermique réduite (min)	kW 2,6
Rendement à la puissance %	min 93,3 % max 91,7 %
Emissions de CO (au 13% de O ₂)	min 122 mg/Nm ³ max 54 mg/Nm ³
Émissions CO (13% O ₂)	min 0,010 Vol.-% max 0,004 Vol.-%
Émissions OGC (13% O ₂)	min 1 mg/Nm ³ max 1 mg/Nm ³
Émissions NOx (13% O ₂)	min 172 mg/Nm ³ max 158 mg/Nm ³
Contenu moyen poussières (13% O ₂)	14 mg/Nm ³
Tirage minimale cheminée	min 10 Pa max 12 Pa
Diamètre sortie fumées	Ø 80 mm
Diamètre conduit d'aspiration	Ø 40 mm
Capacité réservoir	kg 22
Consommation granulés	min 0,54 kg / h max 1,83 kg / h
Tension d'alimentation	V/HZ 230 / 50
Absorption électrique nominale	max 78 W
Absorption électrique en allumage	345 W
Surface de chauffe m ²	66 / 216 m ²
Niveau sonore dB	dB 37 / 44
Combustible	PELLET EN PLUS A1

PLUS

-  Poêle étanche
-  Brasero INOX 316 / en fonte
-  Sortie des fumées supérieure
-  Système de modulation
-  Silence (à puissance réduite)
-  Programmation journalière/hebdomadaire
-  5 régulations de puissance
-  Écran 7 langues
-  Poignée anti-brûlure
-  Vitre céramique

FINITIONS



Métal
Rouge





Métal
Anthracite



Métal
Blanc

OPTIONAL

-  Wi-Fi
-  Télécommande
-  Tiroir à cendres

SOFIA 9.0 UP



PELLET AIR

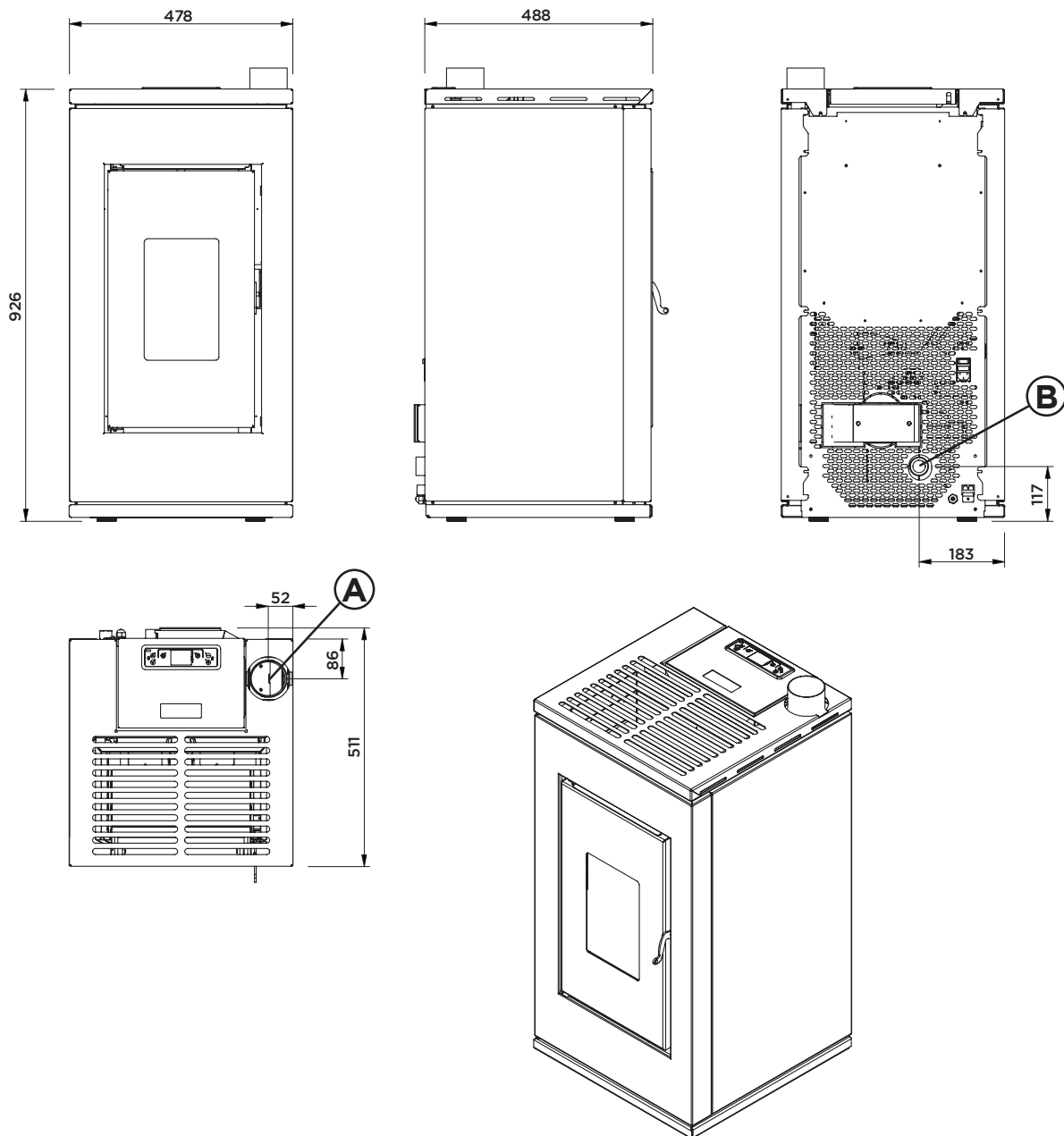

Sortie des fumées	A
Entrée d'air comburant	B
Uscita Canalizzazione	-
Canalisable jusqu'à mètres linéaires (consulter le manuel pour une correcte installation)	-